

This Summer Math Packet is for all students who will be entering 2<sup>nd</sup> grade in the fall of 2016.

Please Note: This packet contains two sections. The first section is a review of grade 1 concepts. The second section is readiness for grade 2.

This packet should be completed prior to the start of school and will be collected during the first week of school.

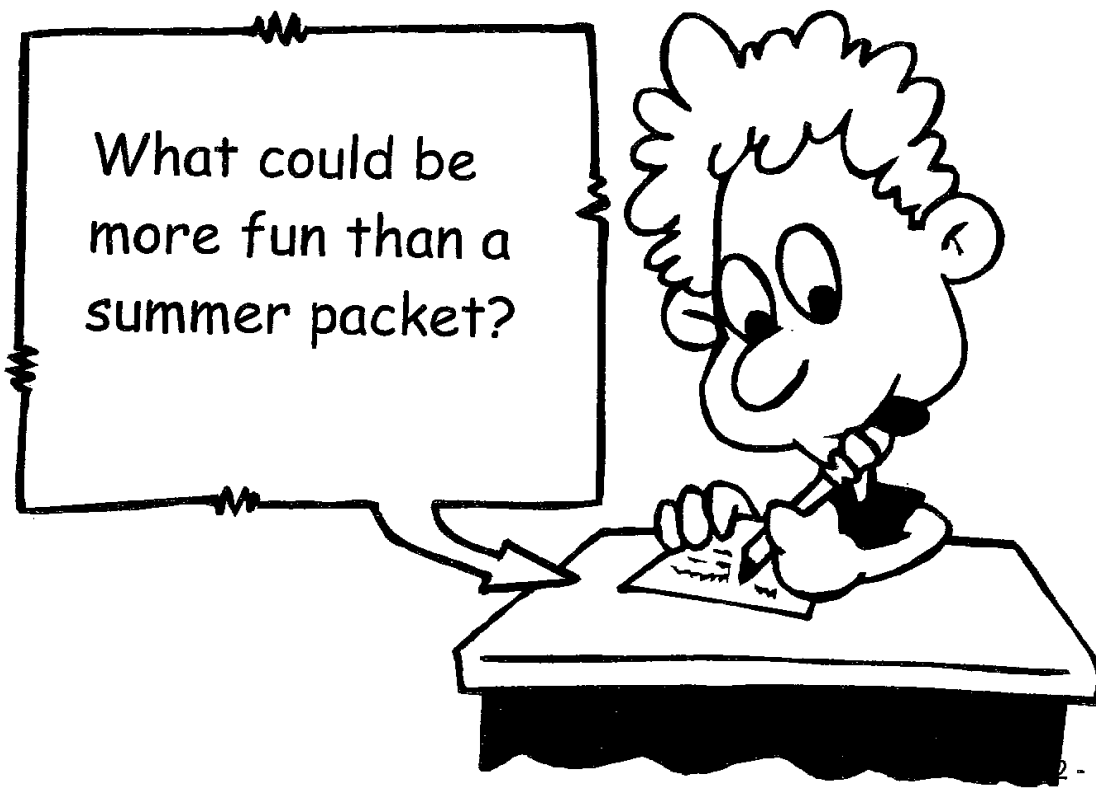

Leo drew 3 counters on a ten-frame.  
How many more counters does he need to make 10?



- A 3
- B 4
- C 6
- D 7

Amir wants some glass and clay beads.  
He can pick 5 beads.  
If Amir picks 4 glass beads, how many clay beads can he pick?

Glass Beads	Clay Beads
0	5
1	4
2	3
3	2
4	1
5	0

- A 0
- B 1
- C 2
- D 5

Which is the sum?



- A 10
- B 12
- C 14
- D 16

What is the sum?



- A 3
- B 5
- C 6
- D 9

Which addition sentence helps you add  $9 + 3$ ?

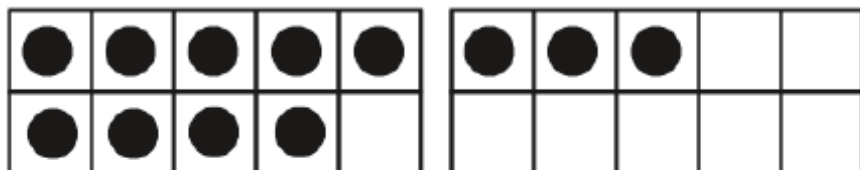

- A  $10 + 1 = 11$
  - B  $10 + 2 = 12$
  - C  $10 + 3 = 13$
  - D  $10 + 4 = 14$
- 

Choose the number sentence that helps you solve the problem.

There are 12 children in the park.  
4 are watching the others play a game.  
How many children are they watching?

- A  $8 - 4 = 4$
  - B  $12 - 8 = 4$
  - C  $12 - 5 = 7$
  - D  $12 - 9 = 3$
- 

Lily has 5 balloons.  
She buys 6 more.  
How many balloons does she have now?

Choose the addition sentence that helps you solve.



- A  $5 + 5 = 10$
- B  $6 + 6 = 12$
- C  $5 + 6 = 11$
- D  $6 - 5 = 1$

There are 6 oranges in each bag.  
How many oranges are there in all?

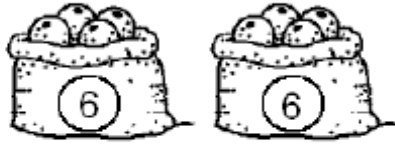

- A 6
- B 9
- C 12
- D 14

What is the missing number?

$6 + 6 = 12$  so  $6 + 7 = \underline{\quad}$

- A 10
- B 11
- C 12
- D 13

Dallas has 14 stickers and 2 cards. Which doubles fact shows how many stickers per card?

- A  $2 + 2 = 4$
- B  $4 + 4 = 8$
- C  $7 + 7 = 14$
- D  $8 + 8 = 16$

Marie has 6 buttons. Her friend gives her 7 more buttons. How many buttons does Marie have in all?

- A 6
- B 12
- C 13
- D 14

Solve.

$2 + 4 = \underline{\quad}$

- A 5
- B 2
- C 6
- D 8

Solve.

$4 + 6 = \underline{\quad}$

- A 8
- B 12
- C 2
- D 10

Which is a related subtraction fact for  $7 + 9 = 16$ ?

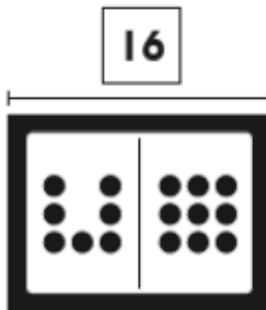

- A  $16 - 9 = 7$
- B  $17 - 9 = 8$
- C  $9 - 7 = 2$
- D  $16 - 8 = 8$

Suri has 12 fish in a tank.

7 of the fish are red. The rest are black.  
How many black fish does Suri have?

$7 + \underline{\quad} = 12$

- A 12
- B 8
- C 5
- D 0

What fact is missing from this fact family?

$9 + 2 = 11$

$11 - 9 = 2$

$11 - 2 = 9$

- A  $9 + 2 = 7$
- B  $9 - 2 = 7$
- C  $2 + 11 = 13$
- D  $2 + 9 = 11$

Which is the missing number?

$16 - 2 = \square$

$2 + \square = 16$

- A 10
- B 12
- C 14
- D 16

What fact is missing from this fact family?

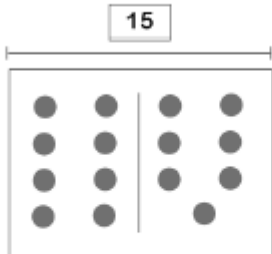
$8 + 7 = 15$ $7 + 8 = 15$ $15 - 8 = 7$	
--	---

- A  $8 - 7 = 1$
- B  $15 - 1 = 14$
- C  $15 + 8 = 23$
- D  $15 - 7 = 8$

Which is the missing number?

$$\begin{array}{r} 18 \\ -13 \\ \hline \square \end{array} \quad \begin{array}{r} 13 \\ + \square \\ \hline 18 \end{array}$$

- A 5
- B 8
- C 18
- D 31

What number is 10 and 7 ones?

- A 8
- B 17
- C 19
- D 20

8 friends on a picnic are eating bologna sandwiches.

7 friends are eating tuna sandwiches.

Which number sentence tells how many more friends are eating bologna sandwiches than tuna sandwiches?

- A  $8 - 8 = 0$
- B  $8 - 1 = 7$
- C  $8 - 7 = 1$
- D  $8 + 7 = 15$

What number is 10 and 9 ones?

- A 15
- B 19
- C 17
- D 20

Cheri ate 11 berries.  
Then she ate 5 more berries.  
How many berries did Cheri eat in all?

- A 16
- B 11
- C 10
- D 5

Pete baked 13 cookies.  
Then he baked 4 more cookies.  
How many cookies does Pete bake in all?

- A 4
- B 8
- C 13
- D 17

Count by tens to find the number.

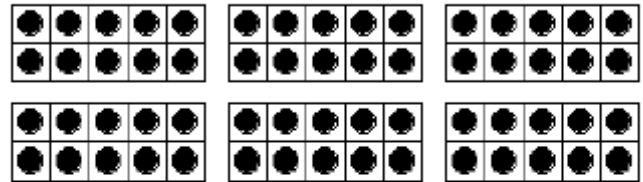

6 groups of 10

- A 20
- B 30
- C 40
- D 60

Count by tens to find the number.

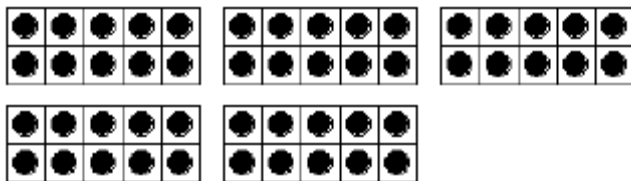

5 groups of 10

- A 20
- B 30
- C 50
- D 70

Start at 35.  
Which number do you say when you count up by 5s?

15	16	17	18	19	20	21	22	23	24
25	26	27	28	29	30	31	32	33	34
35	36	37	38	39	40	41	42	43	44

- A 19
- B 40
- C 28
- D 25

Use the grid below. Start at 30. Skip count by tens.

21	22	23	24	25	26	27	28	29	30
31	32	33	34	35	36	37	38	39	40
41	42	43	44	45	46	47	48	49	50
51	52	53	54	55	56	57	58	59	60

How many numbers did you count?

- A 2
- B 4
- C 30
- D 60

Dan has 65 toy cars.

He made a list to show different ways to make 65.

Which numbers are missing from the list?

Tens	Ones
2	45
3	35
4	25
?	?
6	5

- A 1 and 76
- B 0 and 70
- C 4 and 22
- D 5 and 15

Which number completes the section on the hundred chart?

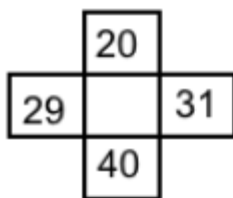

- A 21
- B 28
- C 30
- D 50



I am greater than 20 but less than 40.  
You say my name when you count by fives.  
Which number could I be?

- A 34
- B 24
- C 15
- D 25

I am greater than 25 but less than 40.  
You say my name when you count by twos.  
Which number could I be?

- A 46
- B 32
- C 37
- D 24

Which number completes the section on the hundred chart?

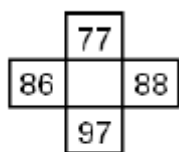

- A 78
- B 87
- C 67
- D 85

Which addition sentence matches the picture?

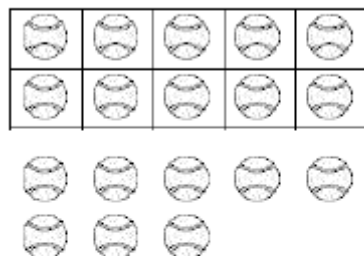

$10 + 8 = \underline{\quad}$

- A 8
- B 10
- C 18
- D 20

There are 6 chickens in one pen.  
A second pen has 10 more chickens than the first pen.  
How many chickens are in the second pen?

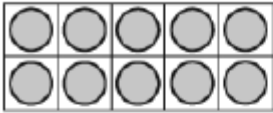

- A 16
- B 11
- C 6
- D 19

Use the hundred chart to add.  
Solve.

$$53 + 40 = \underline{\quad ? \quad}$$

41	42	43	44	45	46	47	48	49	50
51	52	53	54	55	56	57	58	59	60
61	62	63	64	65	66	67	68	69	70
71	72	73	74	75	76	77	78	79	80
81	82	83	84	85	86	87	88	89	90
91	92	93	94	95	96	97	98	99	100

- A 57
- B 95
- C 83
- D 93

Use the hundred chart to add.  
Solve.

$$62 + 10 = \underline{\quad ? \quad}$$

41	42	43	44	45	46	47	48	49	50
51	52	53	54	55	56	57	58	59	60
61	62	63	64	65	66	67	68	69	70
71	72	73	74	75	76	77	78	79	80
81	82	83	84	85	86	87	88	89	90
91	92	93	94	95	96	97	98	99	100

- A 52
- B 42
- C 72
- D 78

Use the hundred chart to add.  
Solve.

$$42 + 20 = \underline{\quad ? \quad}$$

41	42	43	44	45	46	47	48	49	50
51	52	53	54	55	56	57	58	59	60
61	62	63	64	65	66	67	68	69	70

- A 52
- B 54
- C 62
- D 72

Solve.

$79 + 10 = \underline{\quad ? \quad}$

- A 99
- B 69
- C 89
- D 99

Use mental math to add two-digit numbers.

$12 + 30 = \underline{\quad \quad}$

- A 8
- B 15
- C 40
- D 42

Solve.

$37 + 40 = ?$

- A 57
- B 97
- C 77
- D 87

Solve.

$14 + 31 = ?$

- A 20
- B 45
- C 40
- D 54

Solve.

$54 + 20 = ?$

- A 74
- B 94
- C 84
- D 64

Add. Use the part of the hundred chart shown.

$26 + 8 = \underline{\quad \quad}$

21	22	23	24	25	26	27	28	29	30
31	32	33	34	35	36	37	38	39	40
41	42	43	44	45	46	47	48	49	50
51	52	53	54	55	56	57	58	59	60
61	62	63	64	65	66	67	68	69	70

- A 4
- B 24
- C 30
- D 34

Use mental math to add two-digit numbers.

$63 + 20 = \underline{\quad \quad}$

- A 80
- B 83
- C 90
- D 68

Tina has 43 stickers.

Mona has 20 stickers.

How many stickers do they have altogether?

Which number sentence matches the story?

- A  $43 + 20 = 63$
  - B  $43 + 2 = 45$
  - C  $43 - 20 = 13$
  - D  $43 + 20 = 55$
- 

Ruby has 14 goldfish in her fish tank. Tina has 21 goldfish in her fish tank. How many goldfish do they have in all?	
--	--

- A  $21 - 14 = 7$  goldfish
  - B  $14 + 21 = 35$  goldfish
  - C  $14 + 21 = 33$  goldfish
  - D  $21 + 7 = 28$  goldfish
- 

Solve.

$$80 - 20 = \underline{\quad ? \quad}$$

- A 50
  - B 60
  - C 70
  - D 100
- 

Solve.

$$50 - 20 = ?$$

- A 40
- B 3
- C 30
- D 20

Use the hundred chart to subtract.  
 Solve.

$73 - 30 = ?$

41	42	43	44	45	46	47	48	49	50
51	52	53	54	55	56	57	58	59	60
61	62	63	64	65	66	67	68	69	70
71	72	73	74	75	76	77	78	79	80
81	82	83	84	85	86	87	88	89	90
91	92	93	94	95	96	97	98	99	100

- A 53
- B 43
- C 30
- D 23

Solve.

$82 - 5 = \underline{\quad}$

- A 73
- B 76
- C 77
- D 79

Solve.

$67 - 25 = \underline{\quad}$

- A 82
- B 73
- C 52
- D 42

Use the hundred chart to subtract.  
 Solve.

$100 - 10 = ?$

41	42	43	44	45	46	47	48	49	50
51	52	53	54	55	56	57	58	59	60
61	62	63	64	65	66	67	68	69	70
71	72	73	74	75	76	77	78	79	80
81	82	83	84	85	86	87	88	89	90
91	92	93	94	95	96	97	98	99	100

- A 84
- B 95
- C 85
- D 90

Which is the shortest?

A



B



C



D

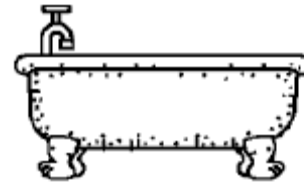

Which piece of chalk is longest?

A



B



C



D



Yesterday it was 70 degrees outside. Today it was 50 degrees outside.  
What was the change in temperature?

Which number sentence best matches the story?

- A  $70 - 50 = 20$
- B  $70 - 50 = 30$
- C  $70 + 50 = 20$
- D  $70 + 20 = 50$

David picked 60 tomatoes last week.  
He picked 20 tomatoes this week.  
How many more tomatoes did he pick last week?

Which number sentence matches the story?

- A  $60 - 40 = 20$
- B  $60 + 20 = 40$
- C  $60 - 20 = 30$
- D  $60 - 20 = 40$

About how many cubes long is the nail?

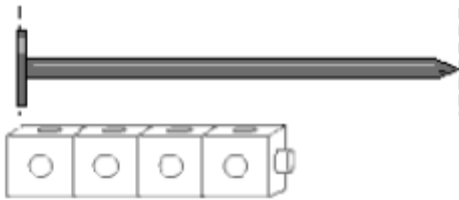

- A 3 cubes
- B 4 cubes
- C 6 cubes
- D 10 cubes

Which clock shows the same time?

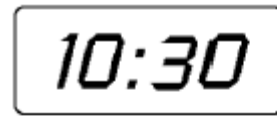

- A
- B
- C
- D

It is time for Peggy to call her friend.  
What time does the clock show?



- A 1:30
- B 2:30
- C 3:30
- D 4:30

Which activity do children do after Math?

Ms. Mayhew's Class Schedule	
8:30	Calendar Activities
9:00	Math
10:00	Art
11:00	Reading
12:00	Lunch

- A Art
- B Reading
- C Lunch
- D Calendar Activities

Which activity comes before Sports?

Summer Camp Schedule	
Time	Activity
9:00	Swimming
10:00	Sports
11:00	Nature Walk
12:00	Lunch
1:00	Art

- A Lunch
- B Nature Walk
- C Sports
- D Swimming

Which shape is a triangle?

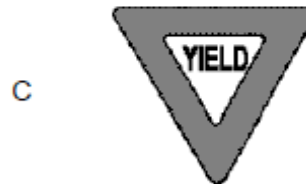

Look at the graph. How many more white counters are there than black?

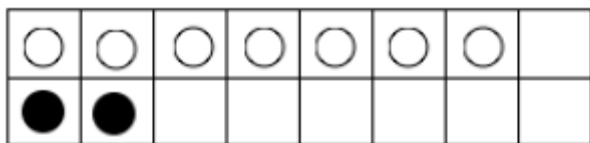

- A 2
- B 4
- C 5
- D 7



A zoo has different animal shows. Each show comes right after the one before it. Which show lasts for 2 hours?

<b><u>Animal Show Schedule</u></b>	
Dolphin Show	11:00
Bird Show	1:00
Petting Zoo	2:00
Seal Show	3:00

- A Dolphin Show
- B Bird Show
- C Petting Zoo
- D Seal Show

























Kent draws crayons from a paper bag filled with red, blue, and purple crayons. He writes down the color of each crayon. Then Kent makes a graph to show his results.

Results of Drawing Crayons from a Bag	
Red	
Blue	
Purple	

How many blue crayons were in the bag?

- A 3
- B 4
- C 5
- D 6



Some children voted for their favorite season. How many more children chose spring than fall?

Favorite Seasons						
 Summer						
 Fall						
 Winter						
 Spring						

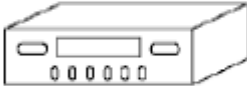

- A 1
- B 2
- C 3
- D 4

Which object has the same shape as a cone?



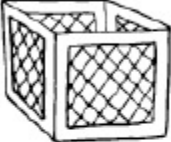

- A 
- B 
- C 
- D 

Which object is NOT shaped like a rectangular prism?

- A 
- B 
- C 
- D 

Which shape shows equal parts?

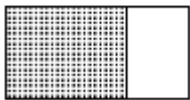
- A 
- B 
- C 
- D 

Which shows one quarter shaded?

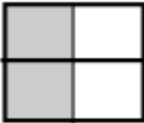
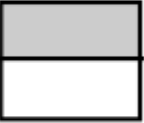
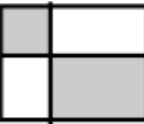
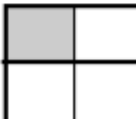
- A 
- B 
- C 
- D 

## Mark the best answer.

1. Which number sentence describes the ten-frame?

- (A) 5 and 3 is 8.
- (B) 2 away from 10 is 8.
- (C) 1 away from 10 is 9.
- (D) 1 more than 10 is 11.

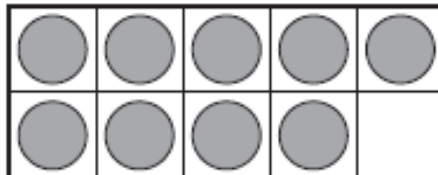

2. Which is a related subtraction fact for  $7 + 8 = 15$ ?

- (A)  $16 - 8 = 8$
- (B)  $15 - 8 = 7$
- (C)  $8 - 7 = 1$
- (D)  $8 - 8 = 0$

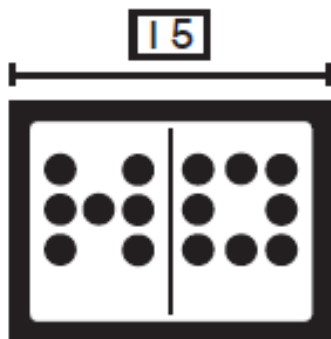

3. Each square in this picture shows 10 ones.  
Which number sentence matches the picture?

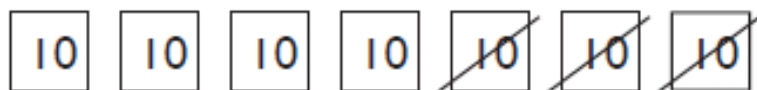

- (A)  $70 - 30 = 40$
- (B)  $40 + 30 = 70$
- (C)  $60 - 30 = 30$
- (D)  $30 + 30 = 60$

4. Chad and Kennard have 9 counters in all. Chad has 5 counters. How many counters does Kennard have? Mark the number sentence that shows how many Kennard has.

$6 = 9 - 3$

(A)

$9 - 6 = 3$

(B)

$9 - 4 = 5$

(C)

$4 = 9 - 5$

(D)

5. Which tells the time it will be in 30 minutes?

(A) 11:30

(B) 12:00

(C) 1:00

(D) 1:30



6. Samantha sees a rectangle that is divided in half. Which shows the shape Samantha sees?

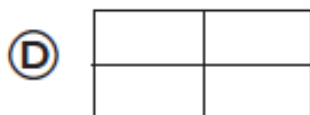
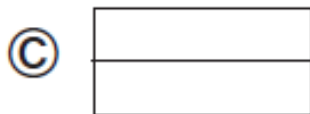
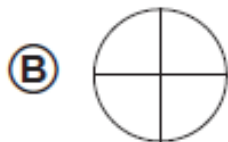
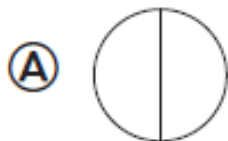

7. Use this part of the hundred chart.

Skip count by 2s. Which number comes next?

2, 4, 6, 8, 10, ?

1	2	3	4	5	6	7	8	9	10
11	12	13	14	15	16	17	18	19	20

- (A) 11
- (B) 12
- (C) 13
- (D) 14

8. Clint has the shortest mailbox. Which mailbox is Clint's?

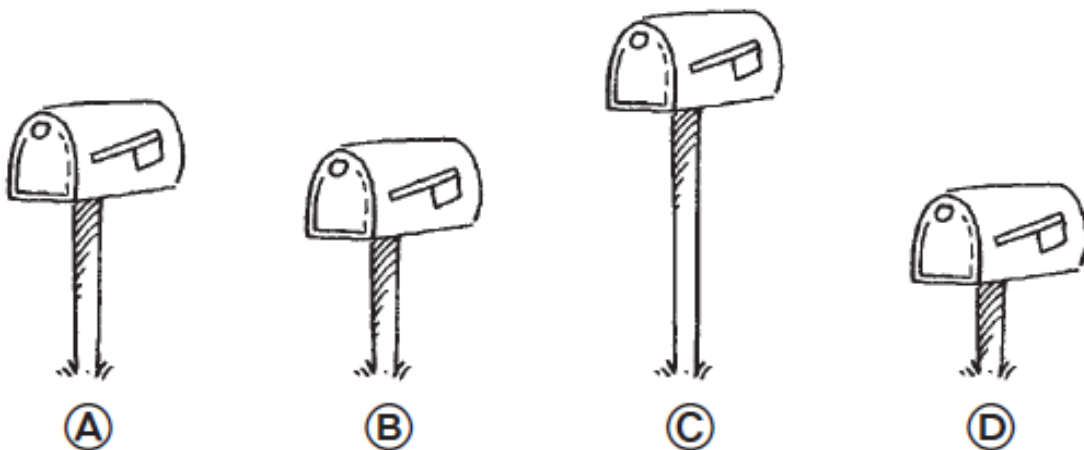

9. There are 3 ducks in the pond. Then 3 more ducks join them. Later, 2 more ducks join them. How many ducks are there in all? Which number sentence helps you solve?

- (A)  $3 + 3 + 2 = 8$
- (B)  $3 + 3 = 6$
- (C)  $3 + 2 = 5$
- (D)  $3 - 3 = 0$

10. Fen has 48 crayons.  
Sylvia has 96 crayons.  
Betsy has the fewest crayons.  
How many crayons can  
Betsy have?

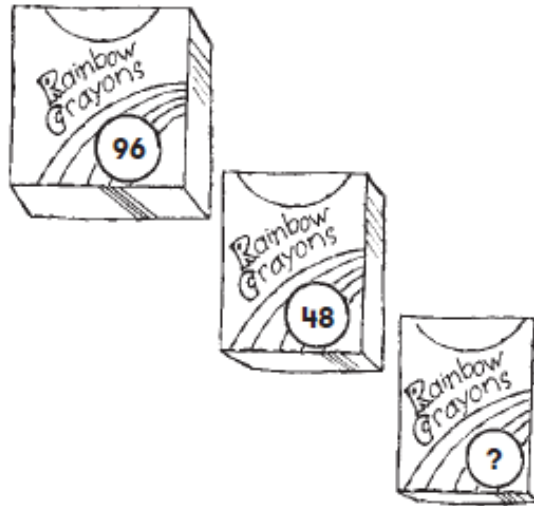

- (A) 120  
(B) 96  
(C) 64  
(D) 32
11. Subtract tens to complete the number sentence.  
 $7 \text{ tens} - 3 \text{ tens} = ?$
- (A) 2 tens  
(B) 3 tens  
(C) 4 tens  
(D) 5 tens
12. How many children chose cat as a favorite pet?

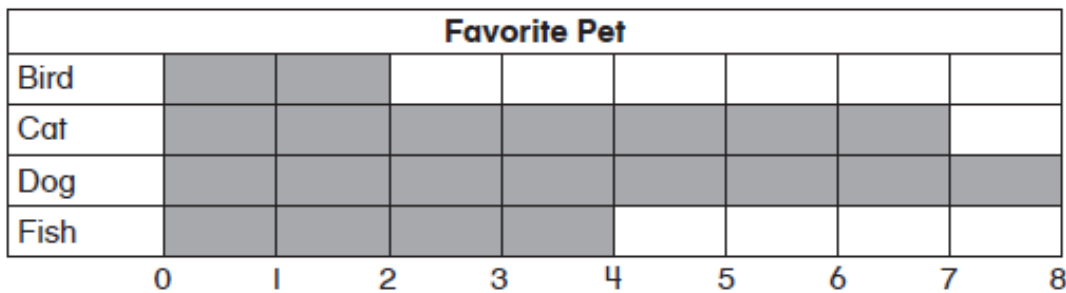

- 8                      7                      4                      2
- (A)                      (B)                      (C)                      (D)